







ST 050 200 1360



- slide bar
- Pipe diameter 18 mm
- rosette Ø 60 mm
- gauge 850 mm
- metal shower hose 1750mm with integrated anti-twist protection
- shower hose connector 1/2"
- COMPACT RAIN, max. flow rate 9 l/min (at 3 bar)
- spray head Ø 64mm
- This product can help a building meet the requirements of Green Building Rating Systems, e.g. LEED®, BREEAM®, DGNB

| | | |
|--|-------------------------------|--------------------|
|  | Chrome | ST 050 200 1360-00 |
|  | Brushed Platinum | ST 050 200 1360-06 |
|  | Platinum | ST 050 200 1360-08 |
|  | Durabress (23kt Gold) | ST 050 200 1360-09 |
|  | Brushed Durabress (23kt Gold) | ST 050 200 1360-28 |
|  | Brushed Dark Platinum | ST 050 200 1360-99 |

Individual components of this set

You need the following components for this set

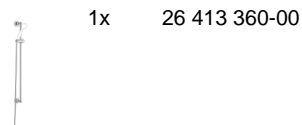
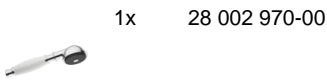



MADISON Shower set - Chrome

MADISON







ST 050 200 1360

ST 050 200 1360



- COMPACT RAIN, max. flow rate 9 l/min (at 3 bar)
- Function from: 6 l/min
- spray head Ø 64mm
- 1/2" connection
- WRAS 1809019

Intrinsic protection against back flow.

| | | |
|--|-------------------------------|--------------------|
|  | Chrome | 28 002 970-00 |
|  | Chrome | 28 002 970-00 0010 |
|  | Gold (23.9kt) | 28 002 970-01 |
|  | Brushed Platinum | 28 002 970-06 |
|  | Brushed Platinum | 28 002 970-06 0010 |
|  | Platinum | 28 002 970-08 |
|  | Platinum | 28 002 970-08 0010 |
|  | Durabress (23kt Gold) | 28 002 970-09 |
|  | Durabress (23kt Gold) | 28 002 970-09 0010 |
|  | Brushed Durabress (23kt Gold) | 28 002 970-28 |
|  | Brushed Durabress (23kt Gold) | 28 002 970-28 0010 |
|  | Brushed Chrome | 28 002 970-93 |
|  | Brushed Chrome | 28 002 970-93 0010 |
|  | Brushed Dark Platinum | 28 002 970-99 |
|  | Brushed Dark Platinum | 28 002 970-99 0010 |

ST 050 200 1360

mm [inches]



Flow rate chart

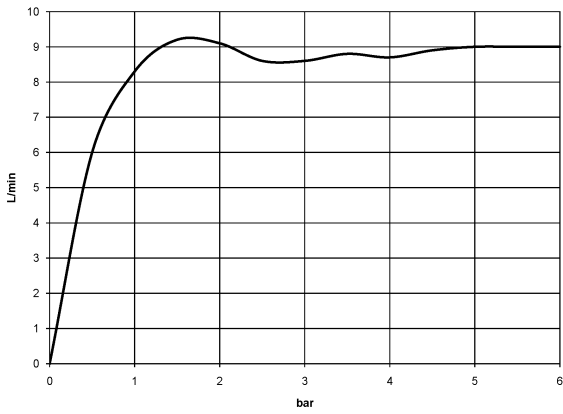

Certificates

WRAS_1809019. LGA_8492.

ST 050 200 1360

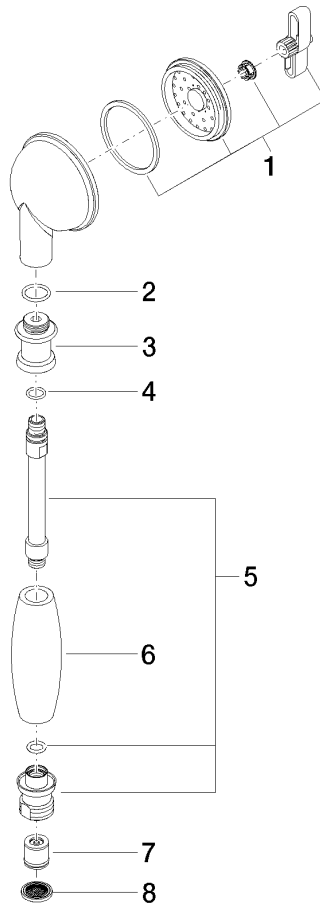

Spare parts list







| No. | Item Number | Name | Quantity used | Delivery time |
|-----|--------------------|--------------|---------------|---------------|
| 1 | 90 12 01 010 00 90 | set | 1 | 2 |
| 2 | 09 14 10 069 90 | seal | 1 | 2 |
| 3 | 09 24 04 059 20-00 | nipple | 1 | 10 |
| 4 | 09 14 10 042 90 | seal | 1 | 2 |
| 5 | 90 28 22 033 00-00 | insert | 1 | 10 |
| 6 | 11 167 820 60 | handle | 1 | 2 |
| 7 | 09 23 01 077 90 | flow reducer | 1 | 2 |
| 8 | 09 23 01 039 90 | sieve | 1 | 2 |

ST 050 200 1360



- slide bar
- Pipe diameter 18 mm
- rosette Ø 60 mm
- gauge 850 mm
- metal shower hose 1750mm with integrated anti-twist protection
- shower hose connector 1/2"

This article does not include a hand shower!

| | | |
|--|-------------------------------|---------------|
|  | Chrome | 26 413 360-00 |
|  | Brushed Platinum | 26 413 360-06 |
|  | Platinum | 26 413 360-08 |
|  | Durabross (23kt Gold) | 26 413 360-09 |
|  | Brushed Durabross (23kt Gold) | 26 413 360-28 |
|  | Brushed Dark Platinum | 26 413 360-99 |

Recommended miscellaneous

| | | |
|---|--|---------------|
|  | Concealed wall elbow - •max. recess depth 163 mm •min. recess depth 90 mm | 35 085 970 90 |
|---|--|---------------|

Recommended miscellaneous

| | | |
|--|------------------------------------|---------------|
|  | MADISON Wall elbow - Chrome | 28 450 410-00 |
|--|------------------------------------|---------------|

Required miscellaneous

| | | |
|---|--|-----------------------|
|  | MADISON Hand shower FlowReduce - Chrome •spray head Ø 95mm •Hand shower see page {PAGE} •Three settings: COMPACT RAIN, COMPACT SOFT FLOW, COMPACT AQUAPRESSURE FLOW, max. flow rate l/min (at 3 bar) | 28 002 978-00 0010 |
|---|--|-----------------------|

Required miscellaneous

| | | |
|---|---|---------------|
|  | MADISON Hand shower - Chrome •spray head Ø 95mm •Hand shower see page {PAGE} •Three settings: COMPACT RAIN, COMPACT SOFT FLOW, COMPACT AQUAPRESSURE FLOW, max. flow rate l/min (at 3 bar) | 28 002 978-00 |
|---|---|---------------|

Required miscellaneous

| | | |
|--|--|-----------------------|
|  | MADISON Metal hand shower with porcelain insert (white) FlowReduce - Chrome | 28 002 970-00 0010 |
|--|--|-----------------------|



MADISON Shower set - Chrome

MADISON

ST 050 200 1360

ST 050 200 1360

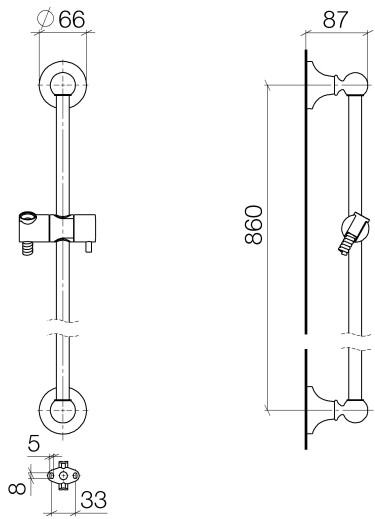

Certificates

WRAS_2009048. IAPMO_4976 (4).

ST 050 200 1360

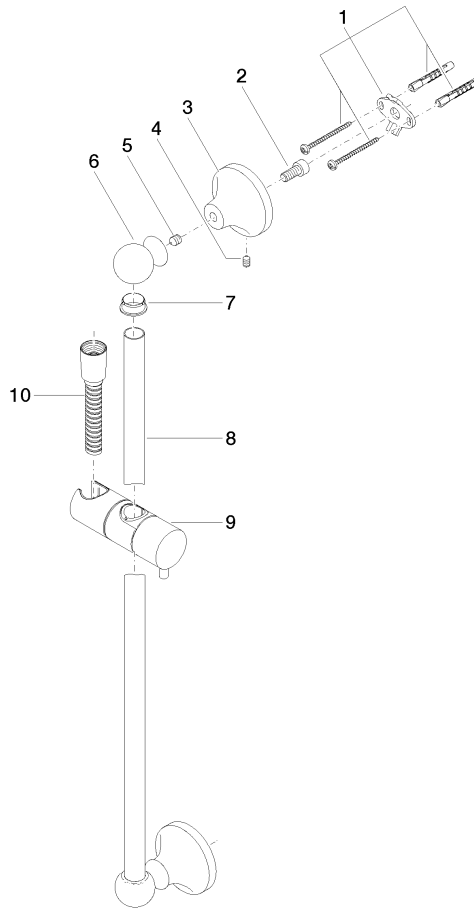

Spare parts list

| No. | Item Number | Name | Quantity used | Delivery time |
|-----|--------------------|--|---------------|---------------|
| 1 | 90 17 20 708 00 90 | fixing set | 2 | 2 |
| 2 | 09 30 30 048 90 | screw | 2 | 2 |
| 3 | 09 17 20 016-00 | holder | 2 | 10 |
| 4 | 09 31 11 144 90 | pin | 2 | 2 |
| 5 | 09 31 11 002 90 | pin | 2 | 2 |
| 6 | 09 21 40 020-00 | connection | 2 | 60 |
| 7 | 09 18 40 009 90 | sleeve | 2 | 2 |
| 8 | 08 28 22 596-00 | pipe | 1 | 10 |
| 9 | 12 580 970-00 | Slide unit - Chrome | 1 | 10 |
| 10 | 28 204 970-00 | Metal shower hose 1/2" x 1/2" x 1750 mm - Chrome | 1 | 2 |